

Dr. Maisch GmbH

Any Column, Any Size, Any Media

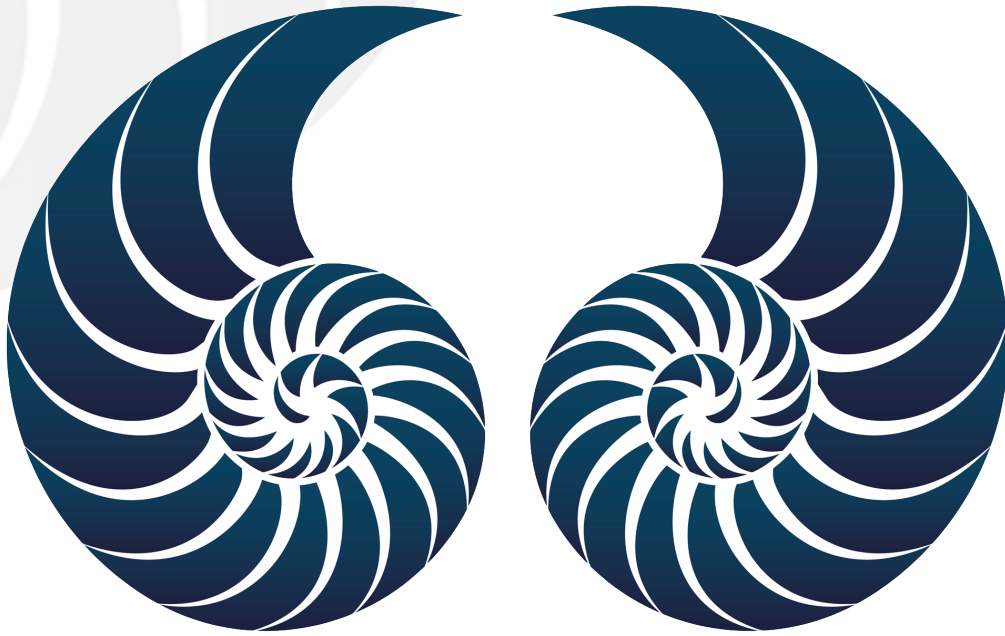

CHIRAL COLUMNS

MADE BY DR. MAISCH

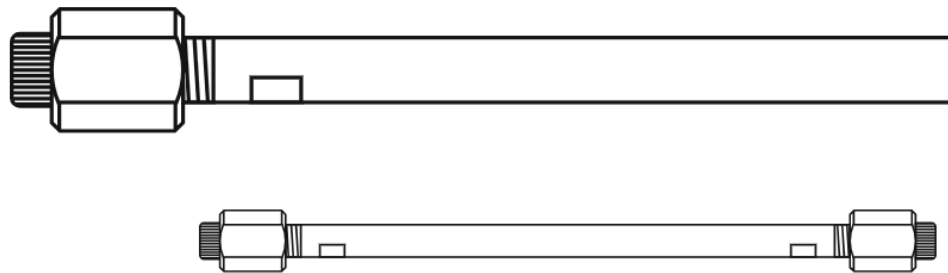

CONTENT

- P 4 - REPOSIL CHIRAL POLYSACCHARIDE PHASES
- CHIRAL SELECTORS NAMES AND STRUCTURES
- P 5 - REPOSIL CHIRAL POLYSACCHARIDE PHASES
- CROSS REFERENCE LIST
- P 6-13 - INDEPENDENT CHIRAL SFC STUDY BY SYAME KHATER
AND CAROLINE WEST, UNIVERSITY OF ORLEANS
- P 14-16 - COMPARISON OF IMMOBILISED REPOSIL CHIRAL
POLYSACCHARIDE PHASES WITH COMPETITORS COATED
EQUIVALENTS
- P 17 - TYPICAL MOBILE PHASE CONDITIONS AND SOLVENT
COMPATIBILITY
- P 18-19 - REPOSIL CHIRAL NR AND NR-R
- P 20 - REPOSIL CHIRAL - AGP
- P 21-22 - PREPARATIVE COLUMNS
- P 23-28 - AVAILABLE COLUMNS AND PRODUCT NUMBERS

**CHIRAL COLUMNS
MADE BY DR. MAISCH**

From one of the biggest **H**igh-**P**erformance
Liquid **C**hromatography (HPLC) - Column
Manufacturers in Europe.



CHIRAL SELECTORS, NAMES & STRUCTURES OF COMMERCIALY AVAILABLE CHIRAL STATIONARY PHASES (CSPs)

„COATED“ REPROSIL CHIRAL POLYSACCHARIDE PHASES

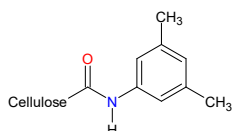

ReproSil Chiral OM
(Chiralcel OD, Lux Cellulose-1)

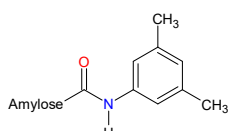

ReproSil Chiral AM
(Chiralpak AD, Lux Amylose-1)

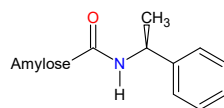

ReproSil Chiral AMS
(Chiralpak AS)

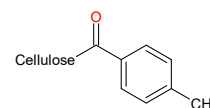

ReproSil Chiral JM
(Chiralcel OJ, Lux Cellulose-3)

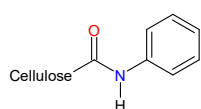

ReproSil Chiral CM
(Chiralcel OC)

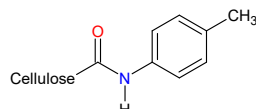

ReproSil Chiral GM
(Chiralcel OG)

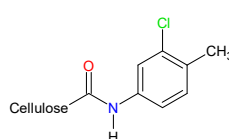

ReproSil Chiral ZM
(Chiralcel OZ, Lux Cellulose-2)

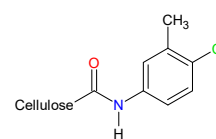

ReproSil Chiral XM
(Chiralcel OX, Lux Cellulose-4)

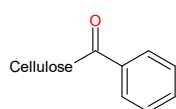

ReproSil Chiral BM
(Chiralcel OB)

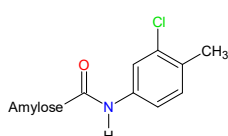

ReproSil Chiral ZA
(Chiralpak AZ)

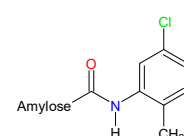

ReproSil Chiral YM
(Chiralpak AY, Lux Amylose-2)

„IMMOBILISED“ REPROSIL CHIRAL POLYSACCHARIDE PHASES

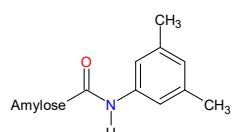

ReproSil Chiral MIA
(Chiralpak IA)

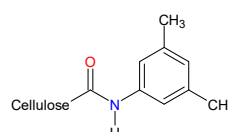

ReproSil Chiral MIB
(Chiralpak IB)

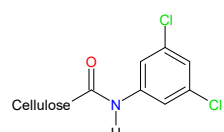

ReproSil Chiral MIC
(Chiralpak IC)

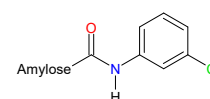

ReproSil Chiral MID
(Chiralpak ID)

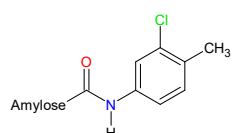

ReproSil Chiral MIF
(Chiralpak IF)

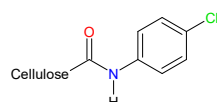

ReproSil Chiral MOF

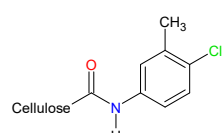

ReproSil Chiral MIX

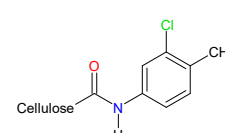

ReproSil Chiral MIZ

**CSPs first introduced to the market
by Dr. Maisch HPLC**

CROSS - REFERENCE

IMMOBILIZED POLYSACCHARIDE PHASES

Dr Maisch phases	Daicel alternative	Phenomenex alternative	Phase description
ReproSil Chiral-MIA	Chiralpak IA	Lux i-Amylose-1	Amylose tris (3,5-dimethylphenylcarbamate)
ReproSil Chiral-MID	Chiralpak ID		Amylose tris (3-chlorophenylcarbamate)
ReproSil Chiral-MIF	Chiralpak IF		Amylose tris (3-chloro-4-methylphenylcarbamate)
ReproSil Chiral-MOF			Cellulose tris (4-chlorophenylcarbamate)
ReproSil Chiral-MIB	Chiralpak IB		Cellulose tris (3,5-dimethylphenylcarbamate)
ReproSil Chiral-MIC	Chiralpak IC	Lux i-Cellulose-5	Cellulose tris (3,5-dichlorophenylcarbamate)
ReproSil Chiral-MIX			Cellulose tris (4-chloro-3-methylphenylcarbamate)
ReproSil Chiral-MIZ			Cellulose (3-chloro-4-methylphenylcarbamate)
ReproSil Chiral-AM	Chiralpak AD	Lux Amylose-1	Amylose tris (3,5-dimethylphenylcarbamate)
ReproSil Chiral-AMS	Chiralpak AS		Amylose tris(S)-a-methylbenzylcarbamate)
ReproSil Chiral-YM	Chiralpak AY	Lux Amylose-2	Amylose tris (5-chloro-2-methylphenylcarbamate)
ReproSil Chiral-ZA	Chiralpak AZ		Amylose tris (3-chloro-4-methylphenylcarbamate)
ReproSil Chiral-BM	Chiralcel OB		Cellulose Tribenzoate
ReproSil Chiral-CM	Chiralcel OC		Cellulose tris (phenylcarbamate)
ReproSil Chiral-GM	Chiralcel OG		Cellulose tris (4-methylphenylcarbamate)
ReproSil Chiral-JM	Chiralcel OJ	Lux Cellulose-3	Cellulose tris (4-methylbenzoate)
ReproSil Chiral-OM	Chiralcel OD	Lux Cellulose-1	Cellulose tris (3,5-dimethylphenylcarbamate)
ReproSil Chiral-XM	Chiralcel OX	Lux Cellulose-4	Cellulose tris (4-chloro-3-methylphenylcarbamate)
ReproSil Chiral-ZM	Chiralcel OZ	Lux Cellulose-2	Cellulose tris (3-chloro-4-methylphenylcarbamate)

MORE THAN 90% OF SEPARATIONS

REPROSIL CHIRAL COLUMNS ARE COMPLEMENTARY AND SUCCESSFUL IN ACHIEVING MORE THAN 90% OF SEPARATIONS OF THE ANALYTES.

ReproSil Chiral AM, JM and OM allow similar hit rates as competitor's CSPs.

REPROSIL CHIRAL COLUMNS

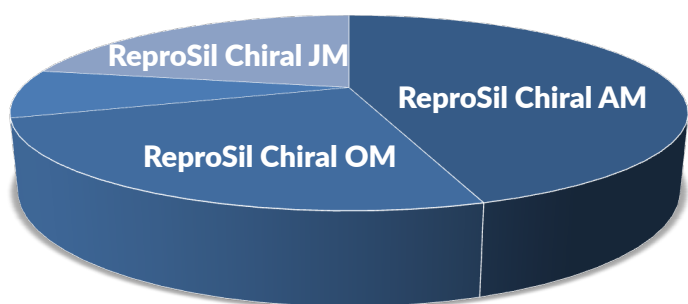

DAICEL CHIRAL COLUMNS

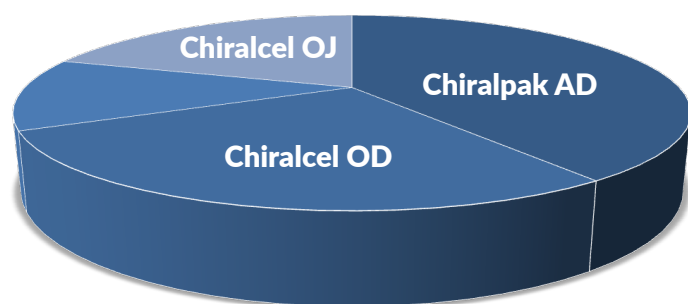

- ReproSil Chiral AM
- ReproSil Chiral OM
- Non resolved enantiomers
- ReproSil Chiral JM

- Chiralpak AD
- Chiralcel OD
- Non resolved enantiomers
- Chiralcel OJ

EXPERIMENTAL

EVALUATION OF REPROSIL CHIRAL OM VS. OD

Evaluation of a silica phase
modified with cellulose tris-(3,5-dimethylphenyl- carbamate)
„ReproSil Chiral-OM“
in supercritical fluid chromatography. Syame Khater and
Caroline West, University of Orleans, CNRS UMR 7311, ICOA.

All experiments were performed on a Jasco SFC system and an Acquity UPC² system. ReproSil Chiral-OM is based on silica coated with tris-(3,5-dimethylphenylcarbamate) of cellulose. Two hundred and thirty achiral compounds and one hundred and thirty chiral racemic compounds were screened on different polysaccharide-type chiral stationary phases in SFC in the following operating conditions: CO₂/MeOH (90:10), flow rate 3 ml/min, oven temperature 25°C, outlet pressure 150 bars.

NON-SPECIFIC INTERACTIONS AND RETENTION

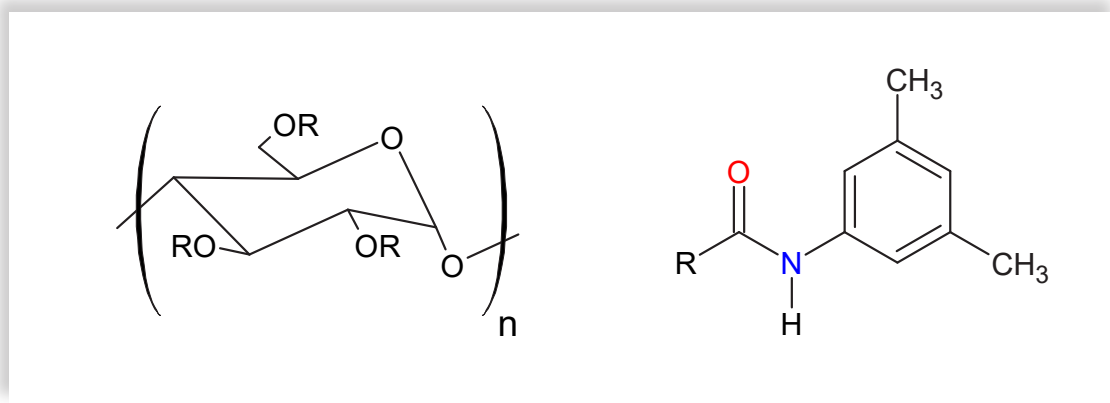

Retention on cellulose tris-(3,5-dimethylphenylcarbamate) could be explained by non-specific interactions such as π - π interactions, hydrogen bonding and stereo-induced interactions.

PERFORMANCE

Log k CHIRAL OD

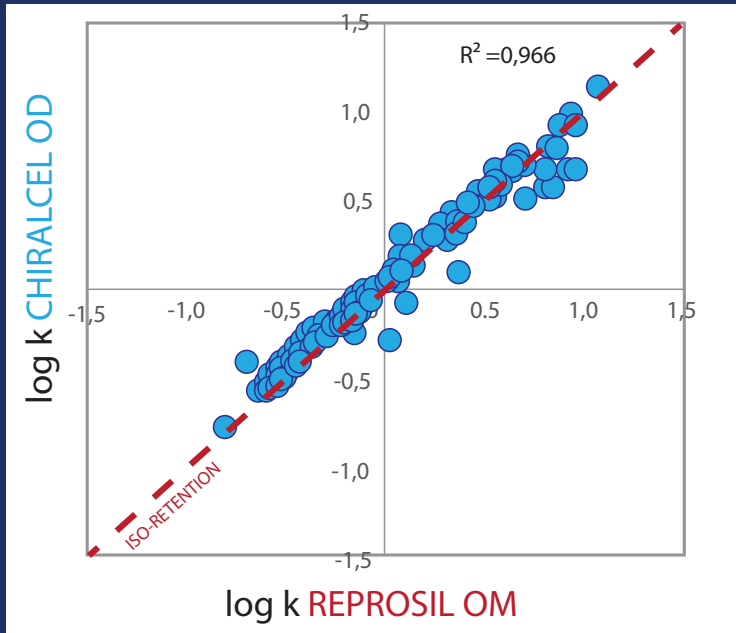

Log k REPOSIL OM

The investigation on non-specific interactions that control retention is based on the analysis of 230 achiral compounds.

The κ - κ plot on the left compares the logarithms of retention factors of 168 achiral species on Chiralcel OD vs. Reprisil Chiral-OM. The phases are expected to be similar since they possess the same chiral selector ($R^2 = 0.966$). They would provide similar non-specific interactions.

Log α CHIRALCEL OD

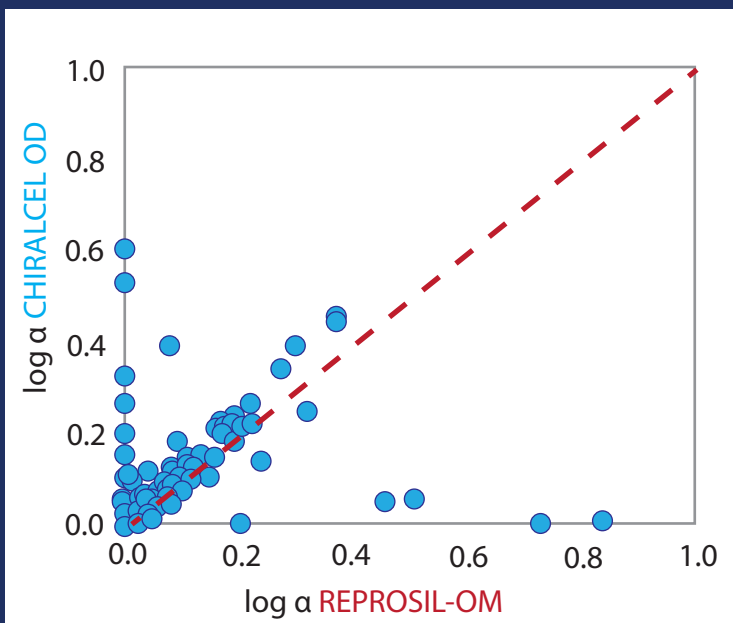

Log α REPOSIL OM

The α - α plot below compares the logarithm of separation factors measured for 130 racemates on Reprisil Chiral-OM vs. Chiralcel OD.

The major part of the compounds is located on the dotted line, indicating similar separation behaviour of the two columns.

Chiralcel OD provides a higher number of unique hits. Indeed, 81% of the tested chiral species are resolved on Reprisil Chiral-OM against 86% on Chiralcel OD. However, some racemates are well separated on Reprisil chiral-OM with little or no separation on Chiralcel OD.

APPLICATIONS

All experiments were performed on a Jasco SFC system and an Acquity UPC² system. ReproSil Chiral-OM is based on silica coated with tris-(3,5-dimethylphenylcarbamate) of cellulose. Two hundred and thirty achiral compounds and one hundred and thirty chiral racemic compounds were screened on different polysaccharide-type chiral stationary phases in SFC in the following operating conditions: CO₂/MeOH (90:10), flow rate 3 ml/min, oven temperature 25°C, outlet pressure 150 bars.

The following chromatograms illustrate the complementarity of the generic phases having cellulose tris-(3,5- dimethylphenyl-carbamate) as chiral selector in the course of method development: Focus on ReproSil Chiral-OM versus Chiralcel OD The chromatograms illustrate the chiral compounds that are well resolved on ReproSil Chiral-OM (a) but have no separation on Chiralcel OD (b).

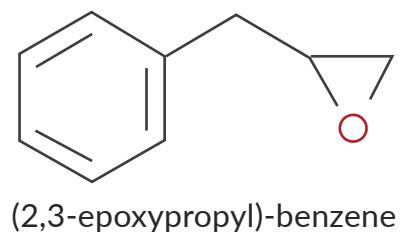
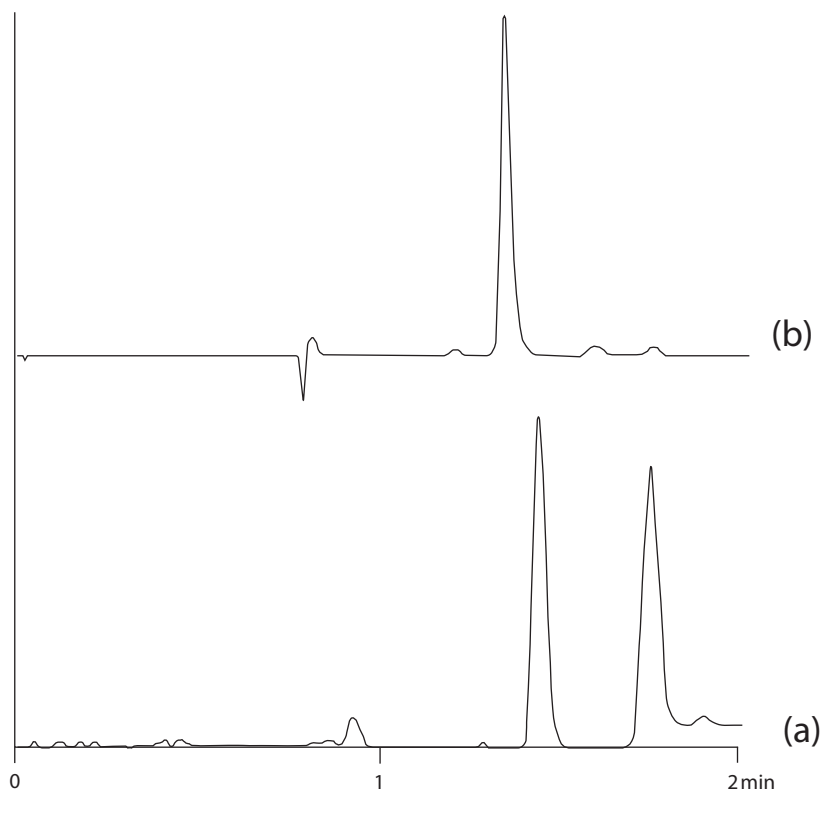

IDENTICAL SELECTIVITY

COMPARISON OF REPOSIL CHIRAL OM AND CHIRACEL OD

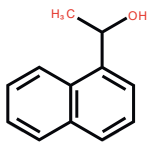
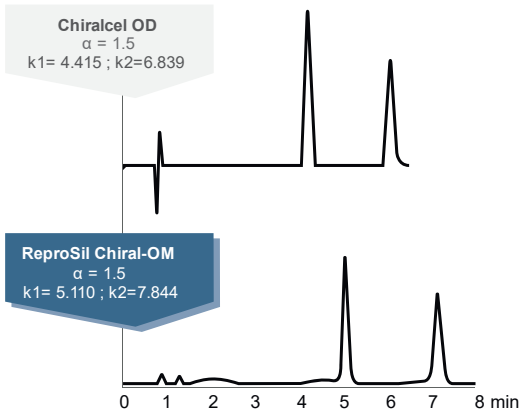

1-(1-Naphthyl)-ethanol

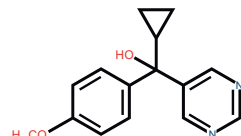
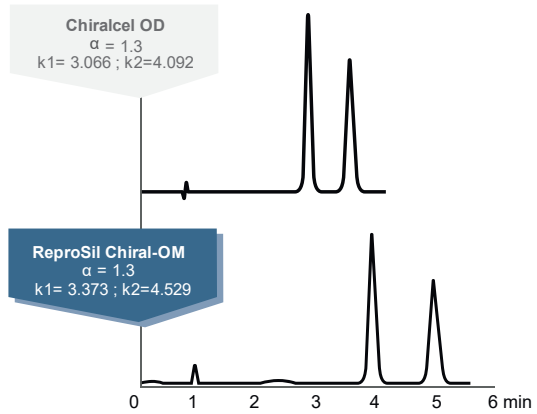

Ancymidol

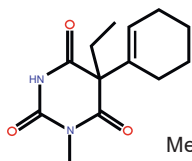
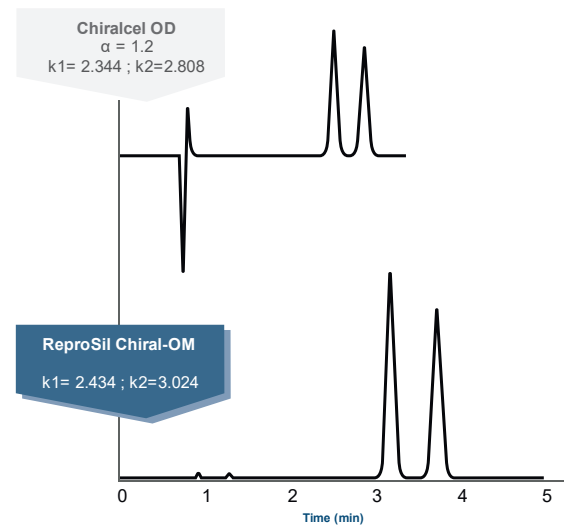

Mephobarbital

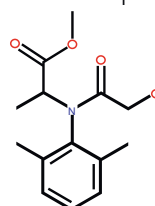
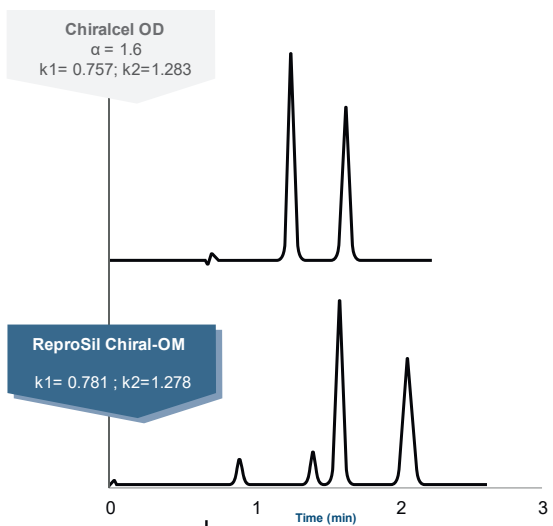

Metalaxyl

COMPARISON OF USP-L40 CHIRAL COLUMNS

The analysis of fenamiphos, glutethimide and 5-methyl-5-phenylhydantoin on ReproSil Chiral-OM provide a better starting point for a method development than those on RegisCell, Lux Cellulose-1 or Cellucoat, respectively.

NO SEPARATION

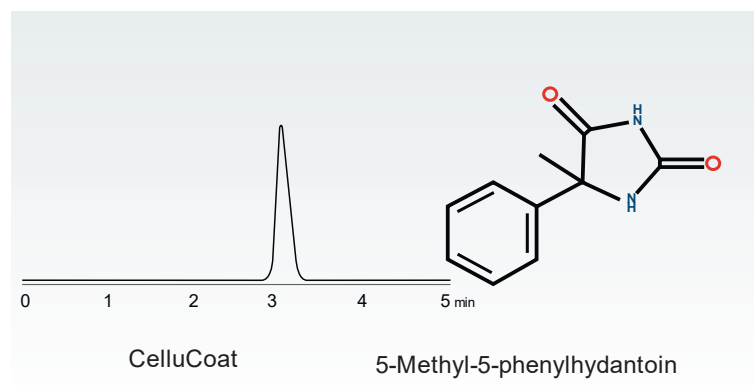
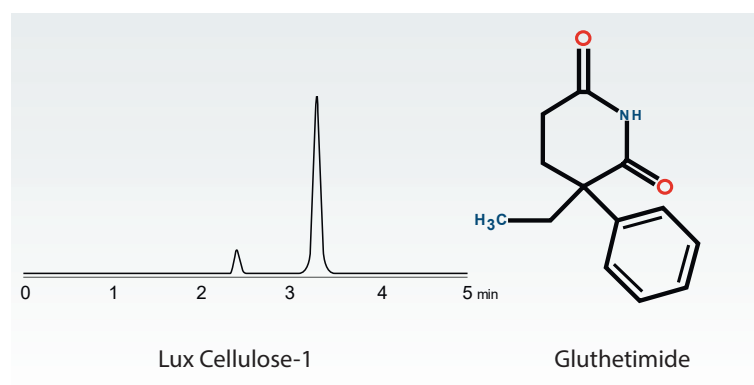
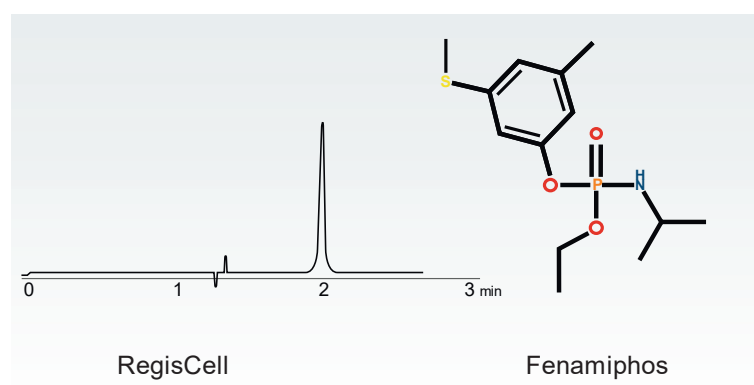

SEPARATION

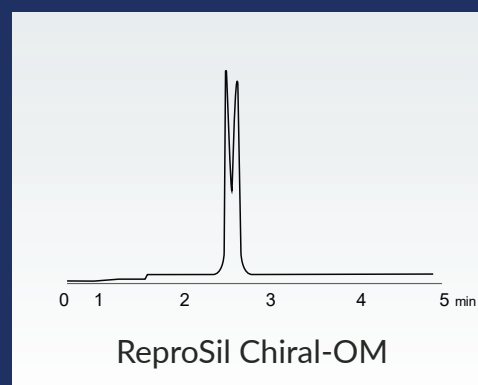
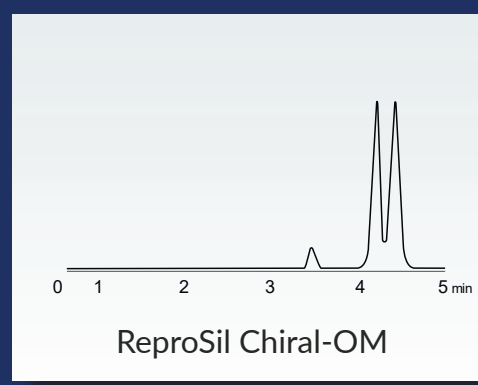
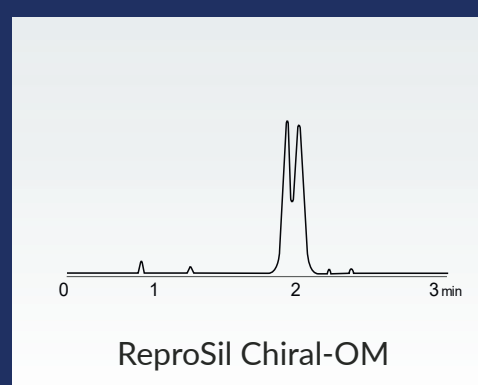

SELECTIVITY OF JM vs. OJ (USP-L80)

The $\log \alpha$ - $\log \alpha$ plot compares the selectivities ability of JM and OJ.

The data points located on the first bisector (red dotted line) show similar separation profiles. The chromatograms of 1-(2-Naphthyl)-ethanol and Fonofos illustrate chiral compounds with identical separation factors on both columns.

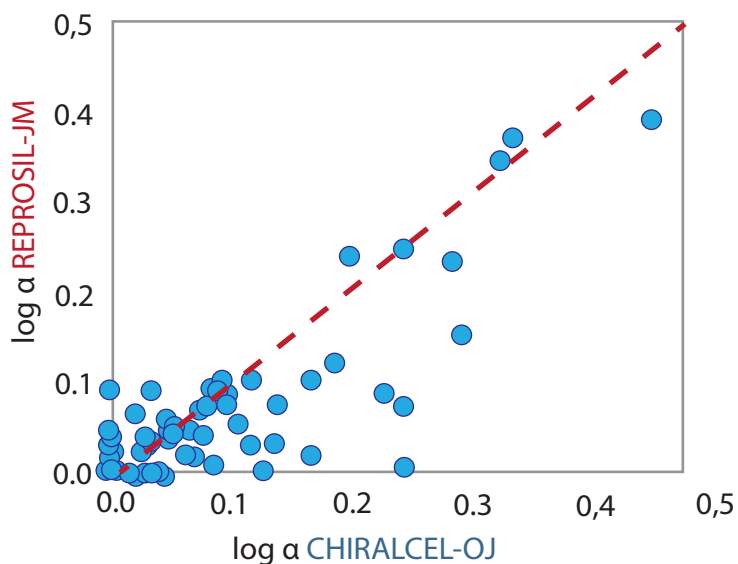
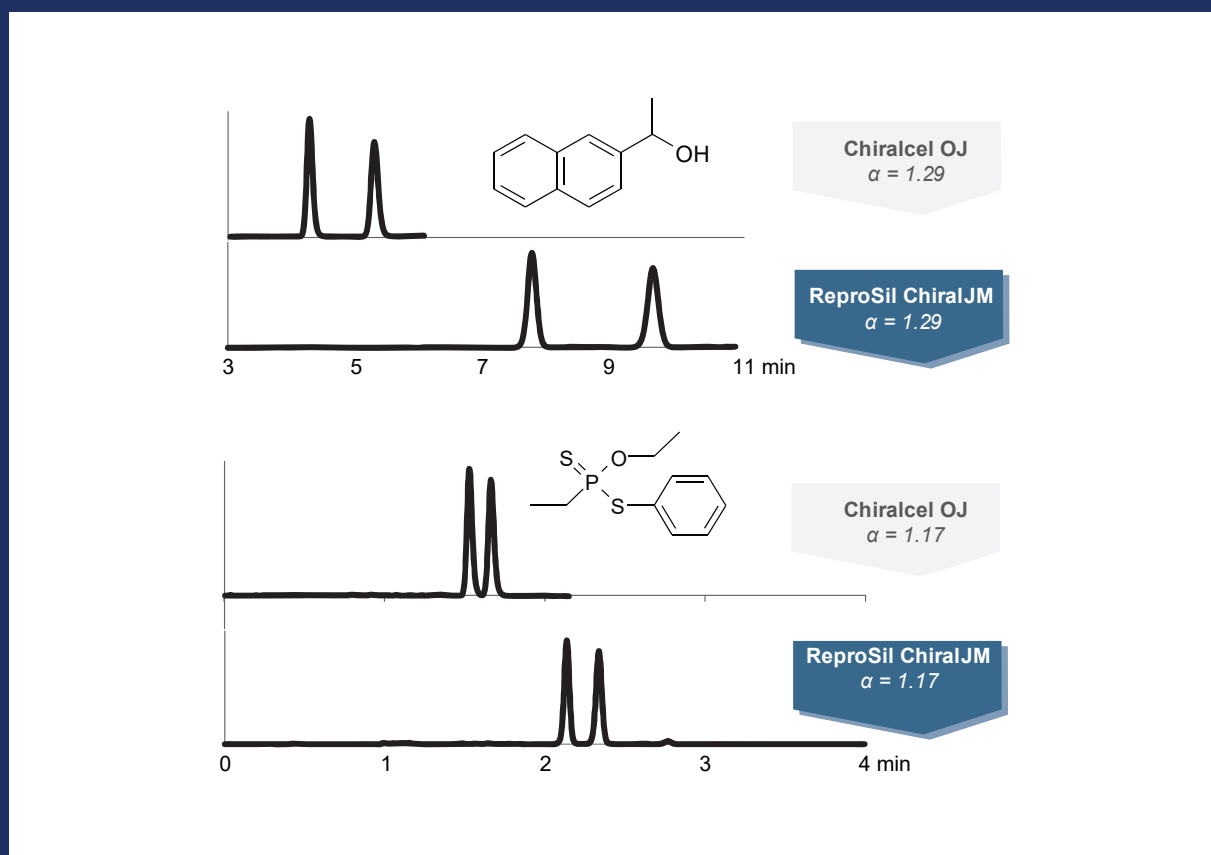

The analysis of Hexobarbital on **ReproSil Chiral-JM** provides a better starting point for a method development than those on **Chiral-AM** or **Chiral-OM**.

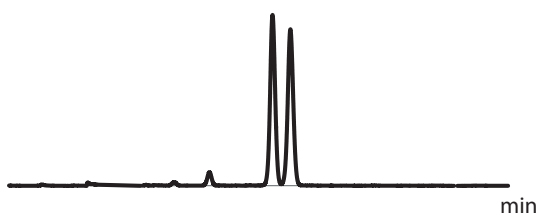
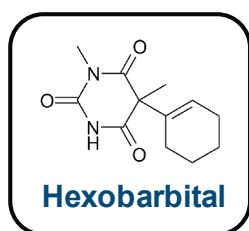

ReproSil Chiral JM

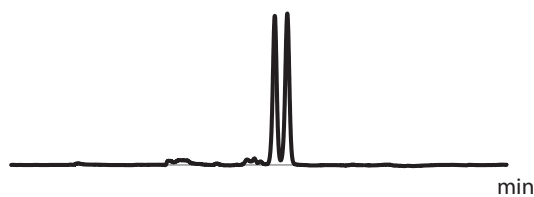
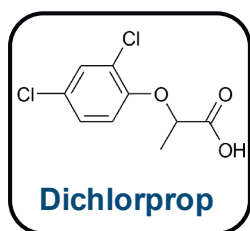

ReproSil Chiral JM

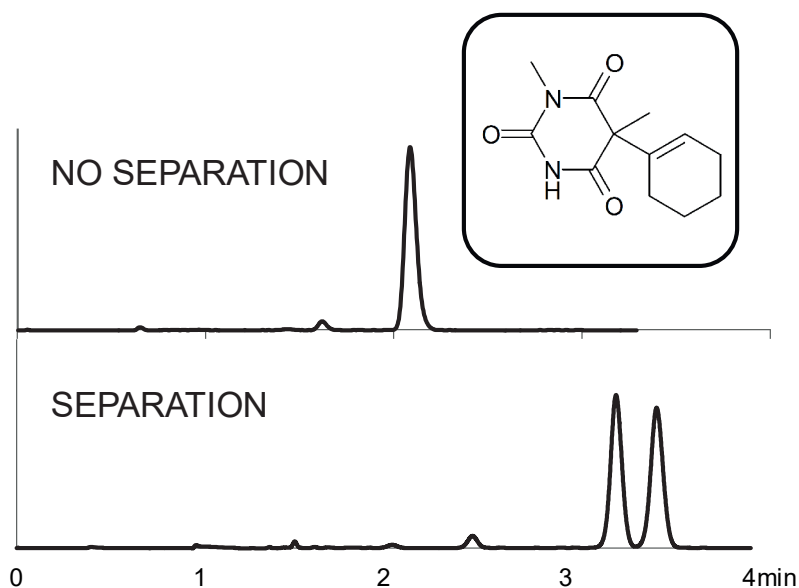

Chiralcel OJ
 $\alpha = 1.0$

ReproSil ChiralJM
 $\alpha = 1.09$

COMPARISON OF UNIQUE IMMOBILISED REPROSIL CHIRAL PHASES WITH COMPETITORS COATED EQUIVALENTS

ReproSil Chiral – unique immobilised phases

SAMPLES

Sample: customer sample

Eluent: CO₂/O - 20% MeOH (0.1% DEA) in 2 min

ReproSil Chiral MIX

5 µm, 100 x 3.0 mm

Lux Cellulose-4

3 µm 100 x 4.6 mm

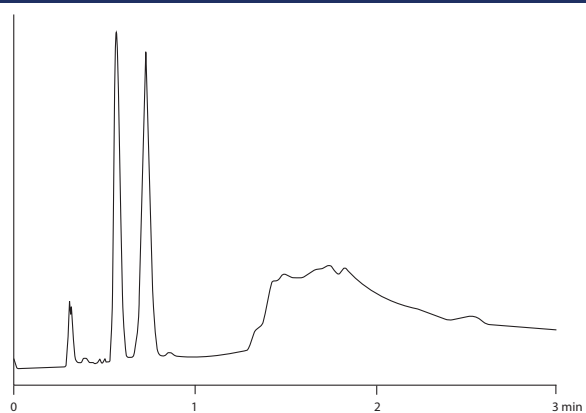

	RT	Areas	%Areas	Resolutions	USP Tailing
1	0,564	220320	39,72		1,20
2	0,726	334417	60,28	2,26	1,04

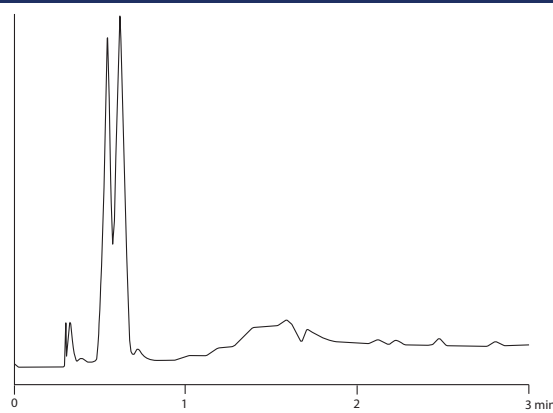

	RT	Areas	%Areas	Resolutions	USP Tailing
1	0,547	647055	44,58		
2	0,626	804384	55,42	0,97	

Sample: TSO

Eluent: CO₂/ 10% MeOH (0.1% DEA)

ReproSil Chiral MIX

5 µm, 100 x 3.0 mm

Lux Cellulose-4

3 µm 100 x 4.6 mm

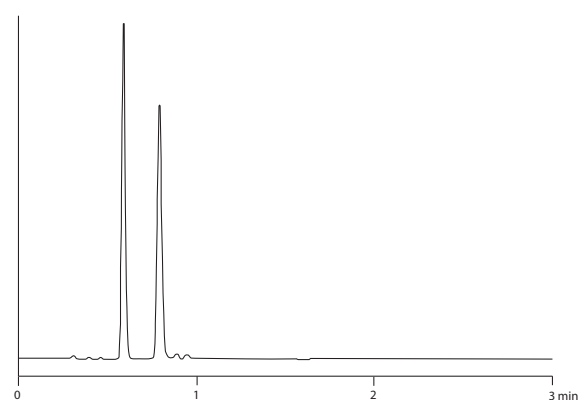

	RT	Areas	%Areas	Resolutions	USP Tailing
1	0,588	1970619	49,64		1,13
2	0,789	1999432	50,36	4,97	1,11

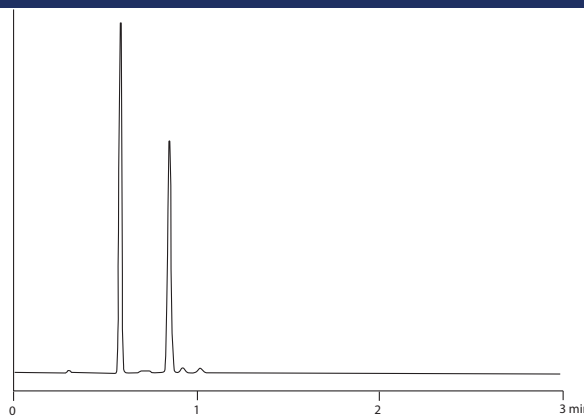

	RT	Areas	%Areas	Resolutions	USP Tailing
1	0,583	1038369	49,91		1,05
2	0,851	1041945	50,09	8,89	1,04

COMPARISON OF UNIQUE IMMOBILISED REPROSIL CHIRAL PHASES WITH COMPETITORS COATED EQUIVALENTS

ReproSil Chiral – unique immobilised phases

SAMPLES

Sample: customer sample

Eluent: CO₂/ 10-50% MeOH (0.1% DEA) in 2 min, hold until 5 min

ReproSil Chiral MIZ

3 µm, 100 x 3.0 mm

Lux Cellulose-2

3 µm 50 x 4.6 mm

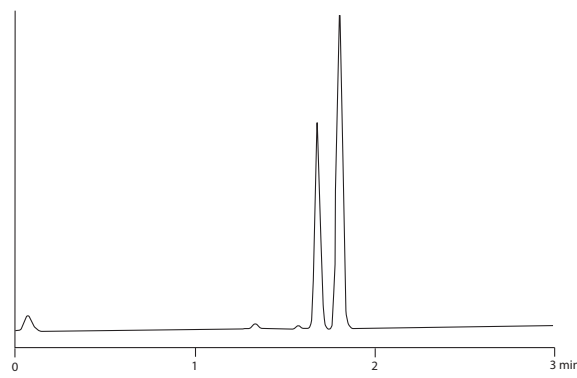
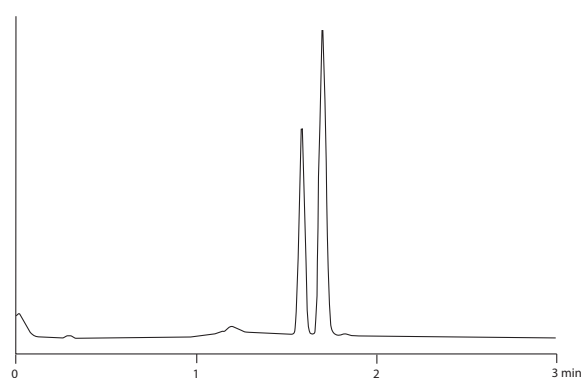

	RT	Areas	%Areas	Resolutions	USP Tailing
1	1,585	1872263	36,75		1,06
2	1,699	3221889	36,25	1,77	1,09

	RT	Areas	%Areas	Resolutions	USP Tailing
1	1,678	1757077	36,89		1,05
2	1,801	3005764	63,11	2,00	1,06

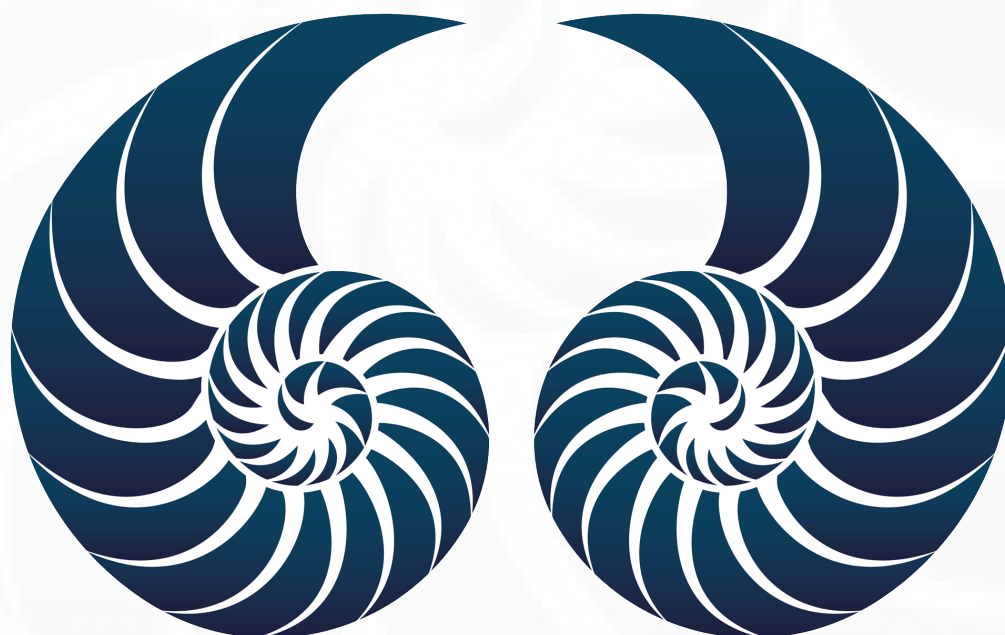

Comparison of unique immobilised ReproSil Chiral phases with competitor's coated equivalents in NP and PO mode

ReproSil Chiral MIX vs. Lux Cellulose-4 under NP/PO conditions

Customer sample

No additives used

Black: Lux Cellulose 4

Colour: ReproSil Chiral MIX

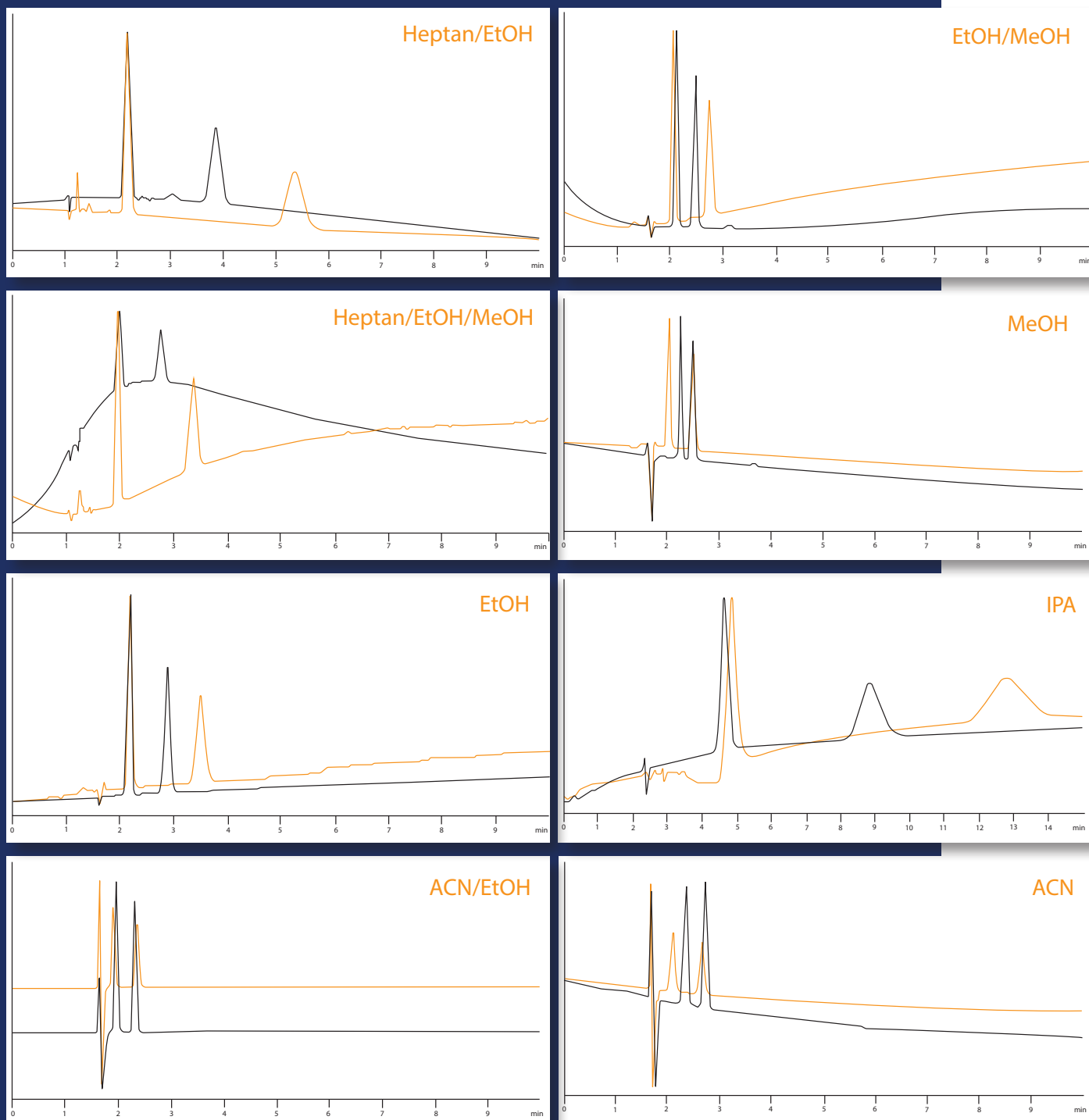

REPROSIL CHIRAL – TYPICAL MOBILE PHASE CONDITIONS

Normal Phase

- Mixtures of hexane or heptane with alcohols (EtOH, IPA) = 80:20 (vary % alcohol to adjust retention time and selectivity)
- Add 0.1 – 0.5% DEA or TEA for basic analytes and 0.1 – 0.5 % TFA or AcO for acidic analytes

Polar Organic Phase

- Mixtures of ACN / IPA (95/5) or MeOH / IPA (90/10) or neat ACN
- Add 0.1 – 0.5% DEA or TEA for basic analytes and 0.1 – 0.5 % TFA or AcOH for acidic analytes

Reversed Phase

- ACN or MeOH or EtOH / water mixtures
- Water content must be < 85%
- Add 0.5 – 1 N perchlorate or 0.1% TFA for basic compounds and HClO₄/NaClO₄ buffer for acidic compounds together with ACN
- Use dedicated column for reversed phase conditions because solvent switch is tedious

Solvent compatibility of coated phases

As the polysaccharide layer is not chemically bonded to the silica support but physically adsorbed, strong solvents have the ability to strip the polymer off the silica support and have therefore to be avoided even in trace amounts or as an injection solvent. Such strong solvents include:

- Ethers incl. THF
- Acetone
- Chlorinated solvents
- Ethyl acetate
- DMSO
- DMF
- Toluene
- Ketones
- Dimethylacetamid
- IPA > 50%

With immobilised phases an extended range of organic solvents can be used as injection solvents and eluents.

Recommended temperature range: 0 – 40°C

Recommended max. pressure: 150 bar

www.dr-maisch.com

ReproSil Chiral NR – unique chemically bonded phase

- Immobilised brush-type phase
- Dinitro compound, acceptor and electron donor phase
- Particularly useful for aromatic compounds with O or N near chiral centre
- NR, RP, SFC mode
- Both antipodes of chiral selector available - elution order reversible

Why ReproSil Chiral NR?

- switch from NP to RP within minutes
- In all common HPLC eluents chemically stable
- amenable to various separation modes and solvents
- scalable
- complementary selectivity
- elution order reversible

CHIRAL PREPARATIVE SEPARATIONS WITH HPLC BY HOFFMANN LA ROCHE, BASEL IN 2014

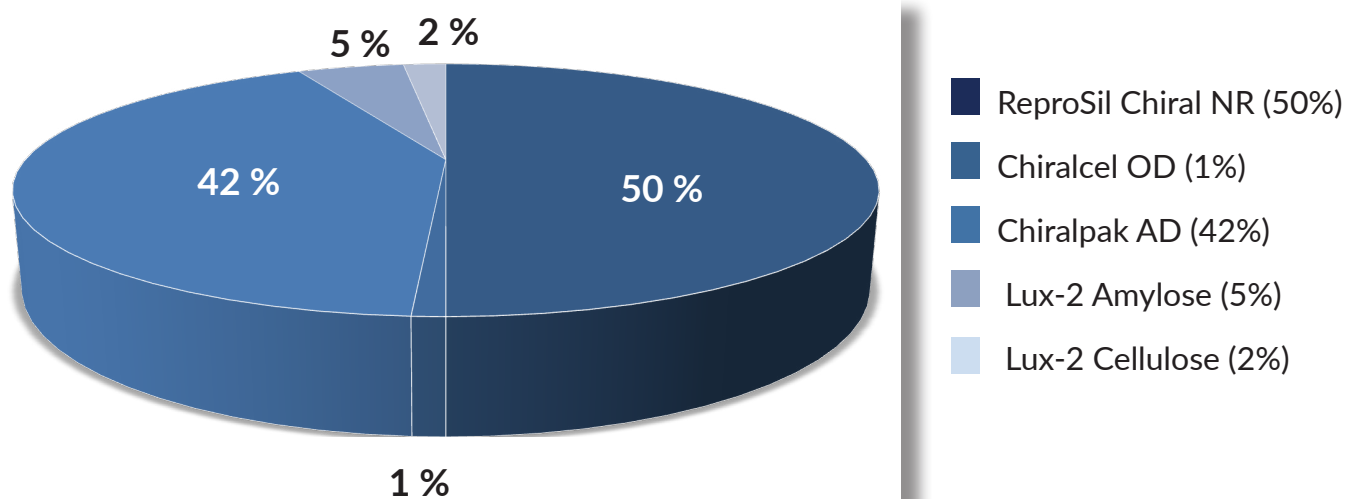

Comparison of ReproSil Chiral NR vs. Whelk-O-1 in SFC mode

Reprosil Chiral NR vs. Whelk-O1

COMPARISON

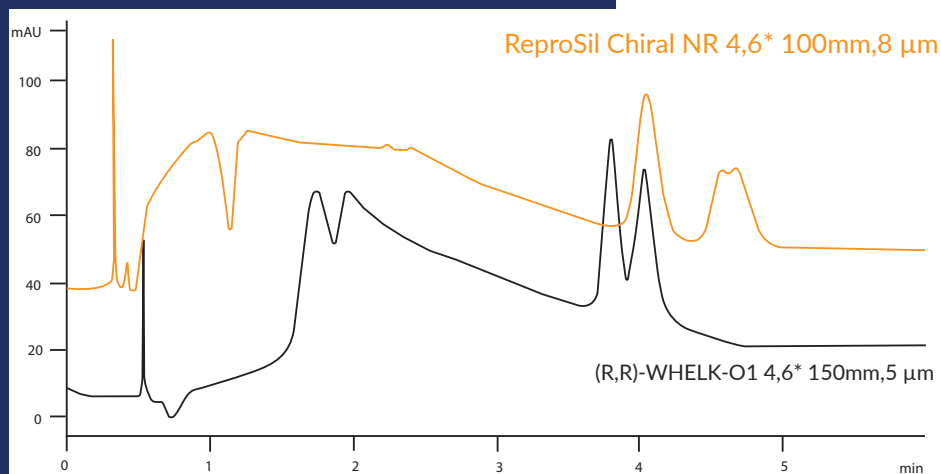

Co-Solvent:
MeOH(0.1%DEA)

Gradient (B%):
10% to 50% in 2.0 min.
hold 1.0 min at 50%

Temperature: 35°C

Flow (ml/min): 4

Back Pressure(psi):
1500.00

Detector: 220nm

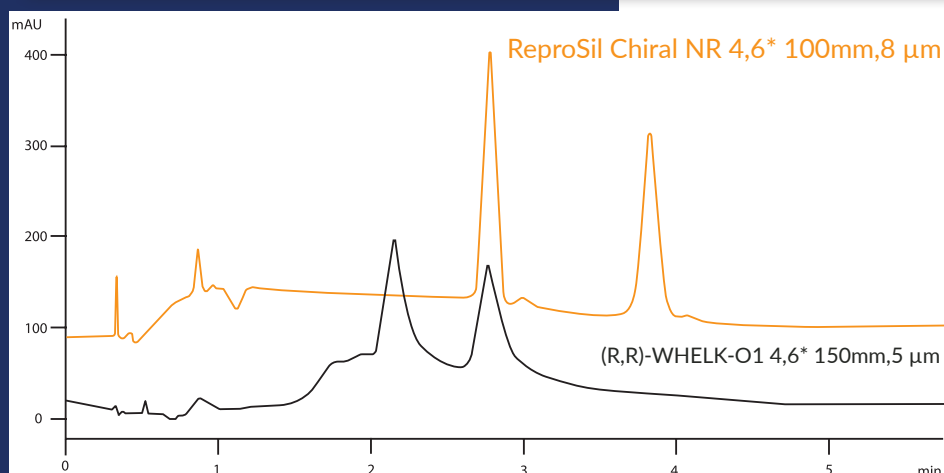
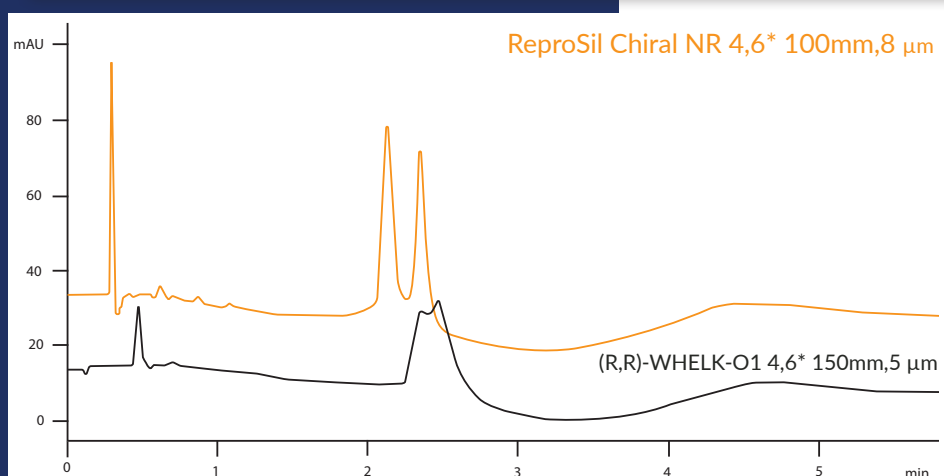

CHIRAL SEPARATION OF IBUPROFEN, WARFARIN AND VERAPAMIL

ReproSil Chiral-AGP, 5 μm

ELUENTS

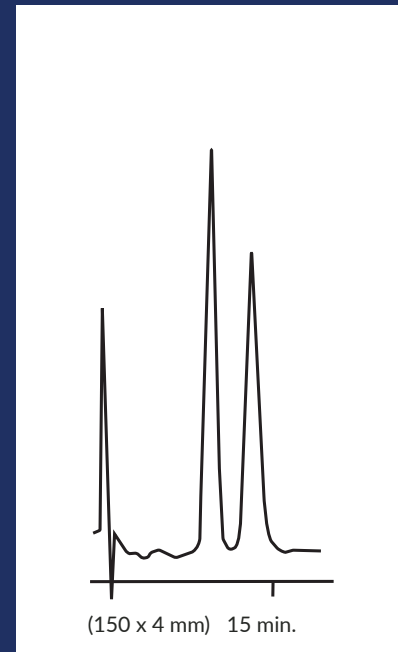
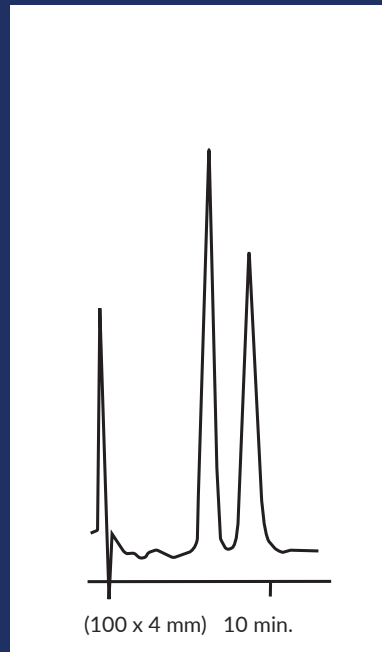
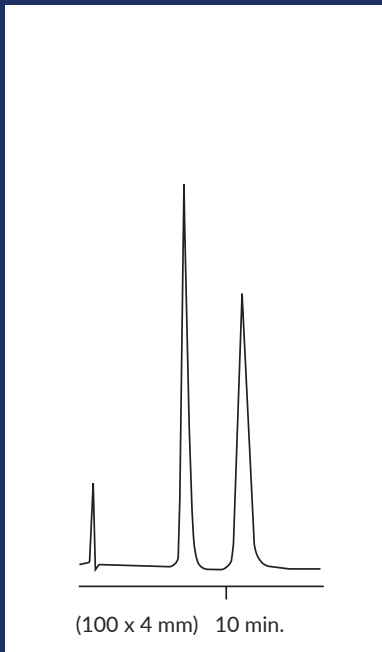

Ibuprofen

100 mM
Na-phosphate buffer, pH7

Warfarin

10% -Propanol in 10 mM
Na-phosphate buffer, pH7

Verapamil

12% ACN in 10 mM
Na-phosphate buffer, pH7

LONGLIFE® Preparative Chromatography Column Hardware

Technology patented by
Dr. Maisch HPLC

LONGLIFE

THE ONLY PREPACKED COLUMN ON THE MARKET
WITH INTEGRATED DYNAMIC AXIAL
COMPRESSION MECHANISM

Available column IDs: 25 mm, 30 mm, 40 mm, 50 mm, 70 mm

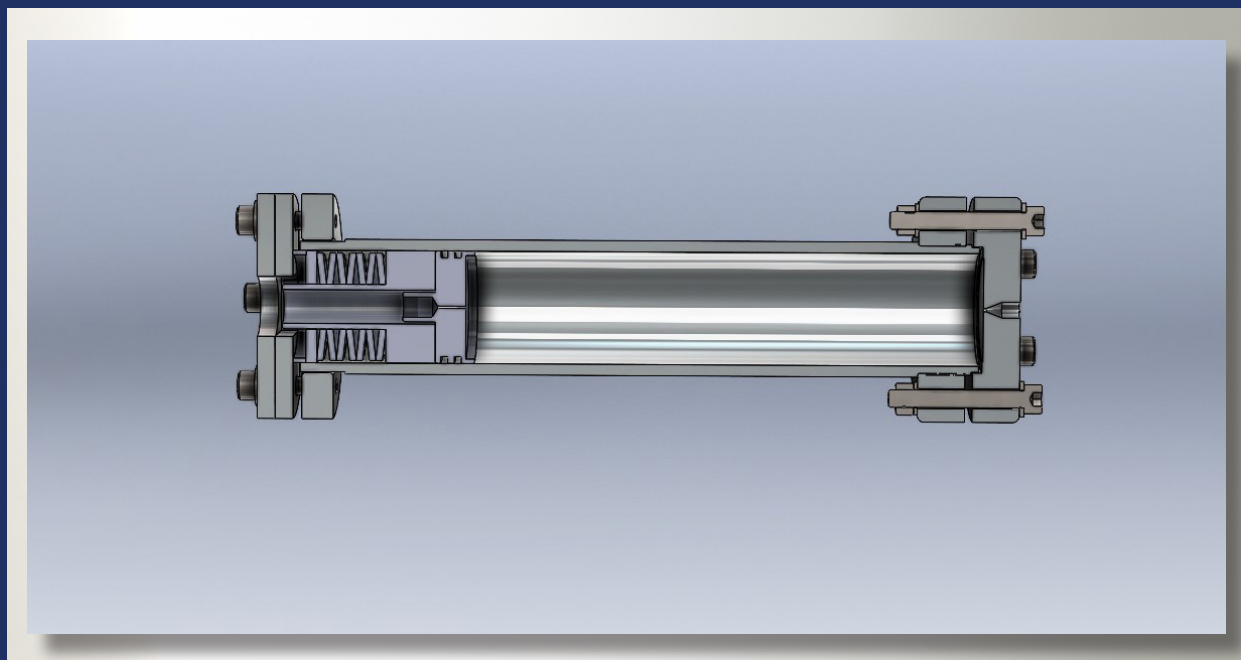

Preparative columns Quality Assurance Chromatogram

ReproSil Chiral-NR, 8 μm upscaling

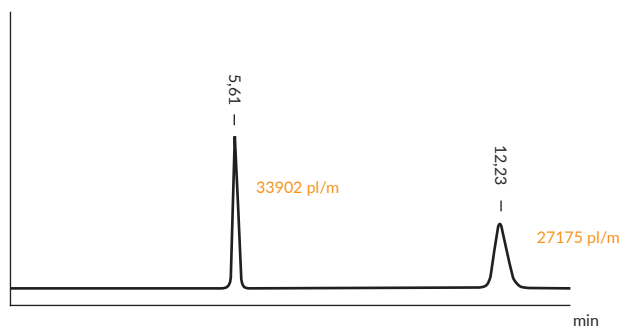

250 x 4,6 mm

Flow: 1ml/min

TEST CONDITIONS

Mobile Phase:
Heptane/IPA 85/15
Temperature: Ambient
Pressure: 15 bar
Detector: UV @ 229 nm
Sensitivity: 0,1 mV

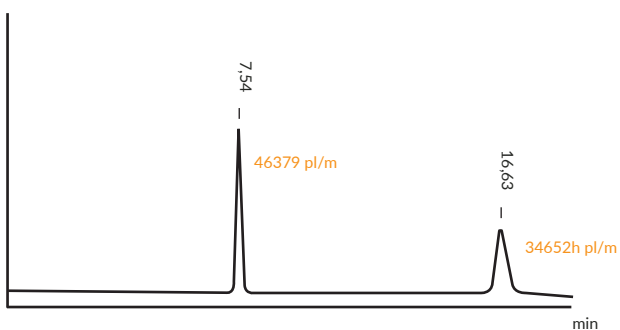

250 x 20 mm

Flow: 15 ml/min

Mobile Phase:
Heptane/IPA 85/15
Temperature: Ambient
Pressure: 9 bar
Detector: UV @ 254 nm
Sensitivity: 0,0 mV

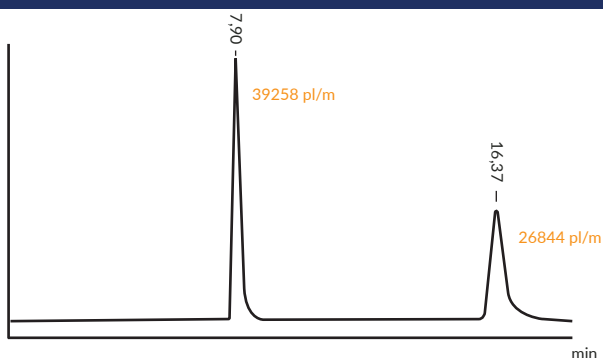

250 x 30 mm

Flow: 30 ml/min

Mobile Phase:
Heptane/IPA 85/15
Temperature: Ambient
Pressure: 11 bar
Detector: UV @ 254 nm
Sensitivity: -0,8 mV

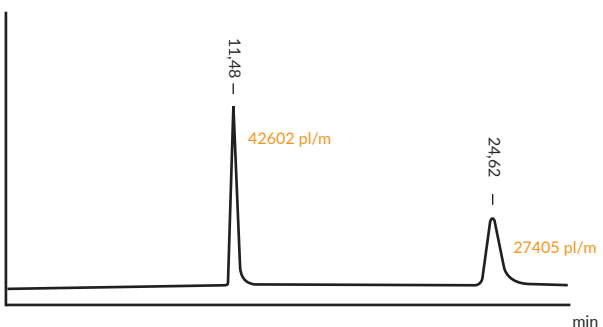

250 x 50

Flow: 60 ml/min

Mobile Phase:
Heptane/IPA 85/15
Temperature: Ambient
Pressure: 12 bar
Detector: UV @ 254 nm
Sensitivity: -0,3 mV

seamless linear scale-up without loss of performance

CHIRAL COLUMNS

Exemplary columns are mentioned below.

Columns with ID of: 4.0 mm, 3.0 mm and 2.0 mm are also available.

Immobilized Amylose-Phases

ReproSil Chiral-MIA Chiral-MIA, 5 µm (or ReproSil Chiral-MIA-R)	Amylose tris-(3,5-dimethylphenyl) carbamate (Alternative to Daicel IA) 250 x 4.6 mm	150 x 4.6 mm	(PN: r65.mia.) 100 x 4.6 mm
ReproSil Chiral-MIF Chiral-MIF, 5 µm (or ReproSil Chiral-MIF-R)	Amylose tris-(3-Chloro-4-Methylphenyl) carbamate (Alternative to Daicel IF) 250 x 4.6 mm	150 x 4.6 mm	(PN: r65.mif.) 100 x 4.6 mm
ReproSil Chiral-MID Chiral-MID, 5 µm (or ReproSil Chiral-MID-R)	Amylose tris-(3-Chlorophenyl) carbamate (Alternative to Daicel ID) 250 x 4.6 mm	150 x 4.6 mm	(PN: r65.mid.) 100 x 4.6 mm

Immobilized Cellulose-Phases

ReproSil Chiral-MIB ReproSil Chiral-MIB, 5 µm (or ReproSil Chiral-MIB-R)	Cellulose tris-(3,5-dimethylphenyl) carbamate (Alternative to Daicel IB) 250 x 4.6 mm	150 x 4.6 mm	
ReproSil Chiral-MIC ReproSil Chiral-MIC, 5 µm (or ReproSil Chiral-MIC-R)	Cellulose tris-(3,5-Dichlorophenyl) carbamate (Alternative to Daicel IC) 250 x 4.6 mm 250 x 10 mm	150 x 4.6 mm 250 x 20 mm	(PN: r65.mic.) 100 x 4.6 mm
ReproSil Chiral-MIC, 3 µm (or ReproSil Chiral-MIC-R)	(Alternative to Daicel IC-3) 250 x 4.6 mm 100 x 4.6 mm	150 x 4.6 mm 50 x 4.6 mm	(PN: r63.mic.) 125 x 4.6 mm 33 x 4.6 mm
ReproSil Chiral-MIX ReproSil Chiral-MIC, 5 µm (or ReproSil Chiral-MIX-R)	Cellulose tris-(4-Chlor-3-Methylphenyl) carbamate 250 x 4.6 mm	150 x 4.6 mm	(PN: r65.mix.) 100 x 4.6 mm
ReproSil Chiral-MIZ ReproSil Chiral-MIZ, 5 µm (or ReproSil Chiral-MIZ-R)	Cellulose tris-(3-Chlor-4-methylphenyl) carbamate 250 x 4.6 mm	150 x 4.6 mm	(PN: r65.miz.) 100 x 4.6 mm
ReproSil Chiral-MIZ, 3 µm (or ReproSil Chiral-MIZ-R)	250 x 4.6 mm 100 x 4.6 mm	150 x 4.6 mm 50 x 4.6 mm	(PN: r63.miz.) 125 x 4.6 mm 33 x 4.6 mm

www.dr-maisch.com

CHIRAL COLUMNS

ReproSil Chiral-MOF	Cellulose tris-(4-Chlorophenyl) carbamate	
ReproSil Chiral-MOF, 5 µm (or ReproSil Chiral-MOF-R)	250 x 4.6 mm 150 x 4.6 mm	(PN: r65.mof.) 100 x 4.6 mm

Coated Cellulose Phases

ReproSil Chiral-OM	USP-L40, Cellulose tris-(3.5-dimethylphenyl-carbamate) mod. Silica		
ReproSil Chiral-OM, 3 µm / Reprisil Chiral-OM-R, 3 µm	Alternatives to Daicel OD-3 / OD-3R		
250 x 4.6 mm	150 x 4.6 mm	125 x 4.6 mm	
100 x 4.6 mm	50 x 4.6 mm	33 x 4.6 mm	
ReproSil Chiral-OM, 5 µm / Reprisil Chiral-OM-R, 5 µm	Alternative to Daicel OD-H / OD-RH		
250 x 4.6 mm	150 x 4.6 mm	100 x 4.6 mm	
250 x 10 mm	250 x 20 mm		
ReproSil Chiral-OM, 10 µm / Reprisil Chiral-OM-R, 10 µm	Alternatives to Daicel OD / OD-R		
250 x 4.6 mm	150 x 4.6 mm	100 x 4.6 mm	
250 x 10 mm	250 x 20 mm		
ReproSil Chiral-OM, 20 µm / Reprisil Chiral-OMR, 20 µm	Alternative to Daicel OD / OD-R		
250 x 4.6 mm	150 x 4.6 mm	100 x 4.6 mm	
250 x 10 mm	250 x 20 mm		
ReproSil Chiral-CM	USP-L70 (Tris-(Phenylcarbamate)-Cellulose mod. Silica)		
ReproSil Chiral-CM, 3 µm	Alternative to Daicel OC-3	150 x 4.6 mm	(PN: r63.cm)
	250 x 4.6 mm		100 x 4.6 mm
ReproSil Chiral-CM, 5 µm	Alternative to Daicel OC-H	150 x 4.6 mm	(PN: r65.cm)
	250 x 4.6 mm		100 x 4.6 mm
	250 x 10 mm		
ReproSil Chiral-JM	USP-L80 (Tris-(4-Methylbenzoyl)-Cellulose mod. Silica)		
	Alternative to Daicel OJ-3 / OJ-3R		
ReproSil Chiral-JM, 3 µm (or Reprisil Chiral-JM-R)	250 x 4.6 mm	150 x 4.6 mm	(PN: r63.jm) 100 x 4.6 mm
	Alternative to Daicel OJ-H / OJ-HR		
ReproSil Chiral-JM, 5 µm (or Reprisil Chiral-JM-R)	250 x 4.6 mm	150 x 4.6 mm	(PN: r65.jm) 100 x 4.6 mm
	250 x 10 mm		
	Alternative to Daicel OJ / OJR		
ReproSil Chiral-JM, 10 µm (or Reprisil Chiral-JM-R)	250 x 4.6 mm	150 x 4.6 mm	(PN: r60.jm) 100 x 4.6 mm
	250 x 10 mm		

CHIRAL COLUMNS

ReproSil Chiral- ZM

Cellulose tris-3-Chloro-4-Methylphenylcarbamate mod. Silica

ReproSil Chiral-ZM, 3 µm (or ReproSil Chiral-ZM-R)	Alternative to Daicel OZ-3 / OZ-3H	(PN: r63.zm)	
	250 x 4.6 mm	150 x 4.6 mm	125 x 4.6 mm
	100 x 4.6 mm	50 x 4.6 mm	33 x 4.6 mm

ReproSil Chiral-ZM, 5 µm (or ReproSil Chiral-ZM-R)	Alternative to Daicel OZ-H	(PN:r65.zm)	
	250 x 4.6 mm	150 x 4.6 mm	100 x 4.6 mm
	250 x 10 mm	250 x 20 mm	

ReproSil Chiral-BM

Tris-(Benzoyl)-Cellulose mod. Silica

ReproSil Chiral-BM, 5 µm / ReproSil Chiral-BM-R	Alternatives to Daicel OB-H / OB-RH		
	250 x 4.6 mm		
	250 x 10 mm	150 x 4.6 mm	100 x 4.6 mm

ReproSil Chiral-BM, 10 µm / ReproSil Chiral-BM-R	Alternatives to Daicel OB / OB-R		
	250 x 4.6 mm	150 x 4.6 mm	100 x 4.6 mm
	250 x 10 mm		

Coated Amylose Phases

ReproSil Chiral-AM

USP-L51, Amylose tris-3,5-dimethylphenylcarbamate mod. Silica

ReproSil Chiral-AM, 3 µm / Reprosil Chiral-AM-R, 3 µm	Alternative to Daicel AD-3 / AD-3R	
	250 x 4.6 mm	125 x 4.6 mm
	100 x 4.6 mm	33 x 4.6 mm

ReproSil Chiral-AM, 5 µm / Reprosil Chiral-AM-R, 5 µm	Alternatives to Daicel AD-H / AD-RH	
	250 x 4.6 mm	100 x 4.6 mm
	250 x 10 mm	250 x 20 mm

ReproSil Chiral-AM, 10 µm / Reprosil Chiral-AM-R, 10 µm	Alternatives to Daicel AD / AD-R	
	250 x 4.6 mm	100 x 4.6 mm
	250 x 10 mm	250 x 20 mm

ReproSil Chiral-AM, 20 µm / Reprosil Chiral-AM-R, 20 µm	Alternatives to Daicel AD / AD-R	
	250 x 4.6 mm	100 x 4.6 mm
	250 x 10 mm	250 x 20 mm

CHIRAL COLUMNS

ReproSil Chiral-AMS

Amylose tris-(S)- α -Methylbenzyl-Carbamate

ReproSil Chiral-AMS, 3 μ m / Reprisil Chiral-AMS-R, 3 μ m Alternatives to Daicel AS-3 / AS-3R

250 x 4.6 mm	150 x 4.6 mm	125 x 4.6 mm
100 x 4.6 mm	50 x 4.6 mm	33 x 4.6 mm

ReproSil Chiral-AMS, 5 μ m / Reprisil Chiral-AMS-R, 5 μ m Alternatives to Daicel AS-H / AS-RH

250 x 4.6 mm	150 x 4.6 mm	100 x 4.6 mm
250 x 10 mm		

ReproSil Chiral-AMS, 10 μ m / Reprisil Chiral-AMS-R, 10 μ m Alternatives to Daicel AS / AS-R

250 x 4.6 mm	150 x 4.6 mm	100 x 4.6 mm
250 x 10 mm		

ReproSil Chiral-ZA

Amylose tris-3-Chloro-4-Methylphenylcarbamate mod. Silica

ReproSil Chiral-ZA, 3 μ m (or Reprisil Chiral-ZA-R) Alternative to Daicel AZ-3 / AZ-3R (PN: r63.za.)

250 x 4.6 mm	150 x 4.6 mm	125 x 4.6 mm
100 x 4.6 mm	50 x 4.6 mm	33 x 4.6 mm

ReproSil Chiral-ZA, 5 μ m (or Reprisil Chiral-ZA-R) Alternative to Daicel AZ-H /AZ-HR (PN: r65.za.)

250 x 4.6 mm	150 x 4.6 mm	100 x 4.6 mm
250 x 10 mm	250 x 20 mm	

ReproSil Chiral-YM

Amylose tris-5-Chloro-2-Methylphenylcarbamate mod. Silica

ReproSil Chiral-YM, 3 μ m (or Reprisil Chiral-YM-R) Alternatives to Daicel AY-3 / AY-3R (PN: r63.ym.)

250 x 4.6 mm	150 x 4.6 mm	125 x 4.6 mm
100 x 4.6 mm	50 x 4.6 mm	33 x 4.6 mm

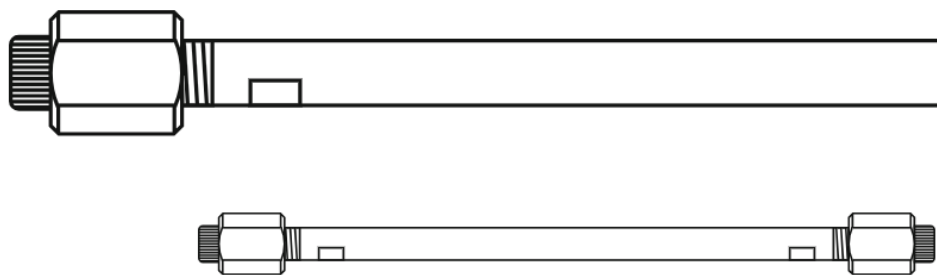

CHIRAL COLUMNS

ReproSil Chiral-NR

Immobilized brush-type phases, Dinitro-compounds.

π -electron acceptor / π -electron donor phase. Particularly for aromatic compounds with O or N near chiral-centre. Chiral separations in NP and RP-Modus

5 μ m	(PN: r15.nr)	250 x 4.6 mm 150 x 4.6 mm 100 x 4.6 mm	
8 μ m	(PN: r18.nr)	250 x 4.6 mm	250 x 10 mm
12 μ m	(PN: r112.nr)	150 x 4.6 mm	250 x 20 mm
15 μ m	(PN: r115.nr)	100 x 4.6 mm	

ReproSil Chiral-NR-R

Reversed Elution order compared to Reprosil Chiral-NR / Antipode of Chiral-NR

(PN: r18.nr)	250 x 4.6 mm	150 x 4.6mm	250 x 10 mm
(PN: r112.nr)	100 x 4.6 mm		250 x 20 mm

Other Chiral Phases

ReproSil Chiral-PS, 8 μ m

Chiral separations in NP and RP-Modus

(for aromatic compounds with S or P, for example: Sulfoxides, Phosphine Oxides, Phosphonates, Thiophosphine Oxides, Phosphin Selenides, Phosphine Boranes)

250 x 4.0 mm (PN: r18.ps.)

ReproSil Chiral-OH, 8 μ m

Chiral separations in NP-Modus

(Aromatic Alcohols with OH near chiral centre, Aryl Carbinols)

250 x 4.0 mm (PN: r18.oh.)

ReproSil Chiral-AA, 8 μ m

(for all amino acids, L-form elutes first)

250 x 4.0 mm (PN: r18.aa.)

ReproSil Chiral-TAG, 8 μ m

Chiral separations in NP and RP-Modus

(Teicoplanin Aglycon: for Aminoalkohols, N-blocked amino acids, α -Hydroxy Acids, Oxazolidinons, Hydantoin, Imides, Amino Acids) USP-L63

250 x 4.0 mm (PN: r18.tag.)

ReproSil Chiral-Beta-CD, 5 μ m

USP-L45 (Dansyl-Aminoacids, Barbiturates, Propranolol Sulfonamide, Prostaglandines)

www.dr-maisch.com

CHIRAL COLUMNS

ReproSil Chiral-Gamma-CD, 5 µm	250 x 4.0 mm (PN: r15.gcd.s2504)		
ReproSil Chiral-D-PhenylGlycin, 5 µm	USP-L36, N-(3,5-Dinitrobenzoyl)-D-Phenylglycin. (Herbicides + Pharmaca (Alcohols, Carbon. acids, Esters, Sulfoxides) Fenoprop-Methyl, Mecoprop-Methyl, Supidimid) 250 x 4.0 mm (PN: r15.DPG.s2504) 250 x 10 mm 250 x 20 mm		
ReproSil Chiral-L-PhenylGlycin, 5 µm	USP-L36 N-(3,5-Dinitrobenzoyl)-L-Phenylglycin. Antipode to D-PhenylGlycin (Herbicides + Pharmaca (Alcohols, Carbon. Acids, Esters, Sulfoxides) Fenoprop-Methyl, Mecoprop-Methyl, Supidimid) 250 x 4.0 mm (PN: r15.LPG.s2504)		
ReproSil Chiral-L-Leucin, 5 µm	N-(3,5-Dinitrobenzoyl)-L-Leucin 250 x 4.0 mm (PN: r15.LL.s2546)		
ReproSil Chiral-L-Prolin, 5 µm	Davankov-Ligand exchange, Aminoacids, Hydantoine, Succinimide, Gluthetimide, Barbiturate, Sulfoxide 250 x 4.0 mm (PN: r15.pr.s2504)		
ReproSil L-Hydroxy-Prolin, 5 µm	Alternative to Nucleosil Chiral-1, USP-L32 Ligand exchange, Eluent: 2-10 mM Coppersulfate, 20-60 C° (For DL-Atrolactinacid, DL-Mandelic acids, DL-Lactic acid, DL-Asparagin, DL-Serin, DL-Phenylalanin, DL-Threonin, DL-Prolin, DL-Histidin, DL-Valin, DL-Tyrosin, DL-Tryptophan), 250 x 4.0 mm (PN: r15.hp.s2504)		
ReproSil Chiral-AGP, 5 µm	300 A° Silicagel with chiral AGP-Protein, USP-L41		
100 x 4.0 mm	(PN: r35.agp.s1004)	150 x 2.0 mm	(PN: r35.agp.s1502)
150 x 3.0 mm	(PN: r35.agp.s1503)	100 x 2.0 mm	(PN: r35.agp.s1002)
100 x 3.0 mm	(PN: r35.agp.s1003)	50 x 2.0 mm	(PN: r35.agp.s0502)
50 x 3.0 mm	(PN: r35.agp.s0503)		
Guards: 5 x 3.0 mm: 2 pieces	(PN: r35.agp.v0003)	Guards: 5 x 2.0 mm: 2 pieces	(PN: r35.agp.v0002)
Guard-holder, direct	(PN:81.00)	Guard-holder, direct	(PN: 91.00)

Dr. Maisch GmbH

Any Column, Any Size, Any Media

Dealer:

Dr. Maisch HPLC GmbH
Beim Brückle 14
D-72119 Ammerbuch
T: +49 7073 50357
F: +49 7073 4216
www.Dr-Maisch.com
www.MODcol.com
Ust-ID: 197557181

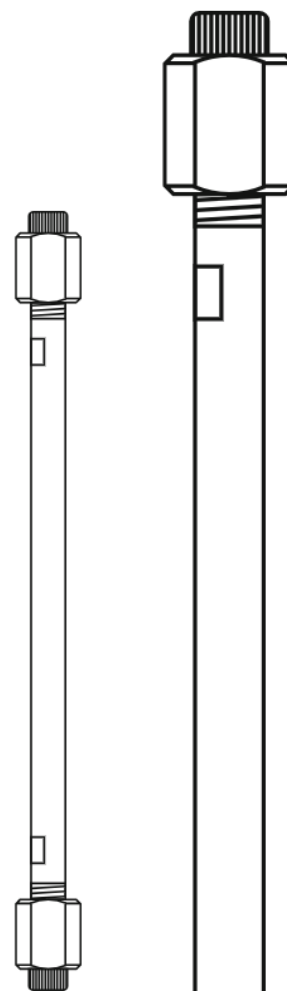

www.dr-maisch.com